

PM160	
Caudal a 900 R.P.M Débit à 900 R.P.M Flow rate at 900 R.P.M	160 l/min
Cilindrada Cylindrée Capacity	177.77 cc/v
R.P.M Max.	1500
Presión máxima Pression maxi Max.Presure	10 Bar
Temperatura máxima Température maximale Maximum temperature	100°C
Sentido de giro Sens de rotation Turning direction	Independiente Indépendant Independent

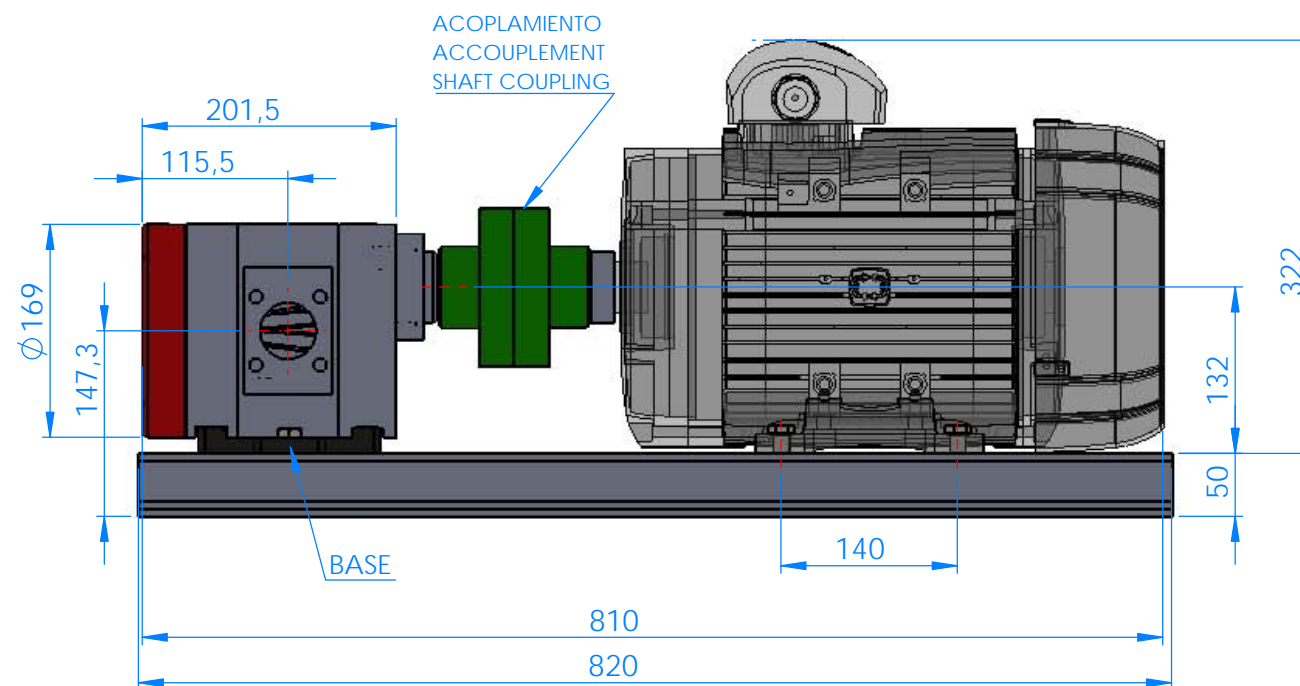

Motor B3	
Velocidad Vitesse Speed	900 R.P.M
Potencia Puissance Power	4 C.V - 3 Kw
Tensión Tension Tension	230-400V
Tipo Type Type	IEC 132 S-6

