

PM 160	
Caudal a 900 R.P.M Débit à 900 R.P.M Flow rate at 900 R.P.M	160 l/min
Cilindrada Cylindrée Capacity	177.77 cc/v
R.P.M Max.	1500
Presión máxima Pression maxi Max.Presure	10 Bar
Temperatura máxima Température maximale Maximum temperature	100°C
Sentido de giro Sens de rotation Turning direction	Independiente Indépendant Independent
Peso Poids Weight	26.7 Kg

Materiales/Matériau/Material	
Cuerpo y tapas Corps et couvercles Body and covers	Inox AISI 316 Inox AISI 316 S.S AISI 316
Ejes Axes Shaft	Inox AISI 316 Inox AISI 316 S.S AISI 316
Engranajes Engrenages Gears	Inox AISI 420/PEEK Inox AISI 420/PEEK S.S AISI 420/PEEK
Casquillos Casquettes Bushings	Grafito/PEEK Graphite/PEEK Graphite/PEEK
Elastómeros Elastomères Elastomers	Vitón Viton Viton
Cierre mecánico Garniture mécanique Mechanical seal	Csi,Csi,Viton
Camara de calentamiento Chambre de chauffage Heating chamber	Aluminio Aluminium Aluminium

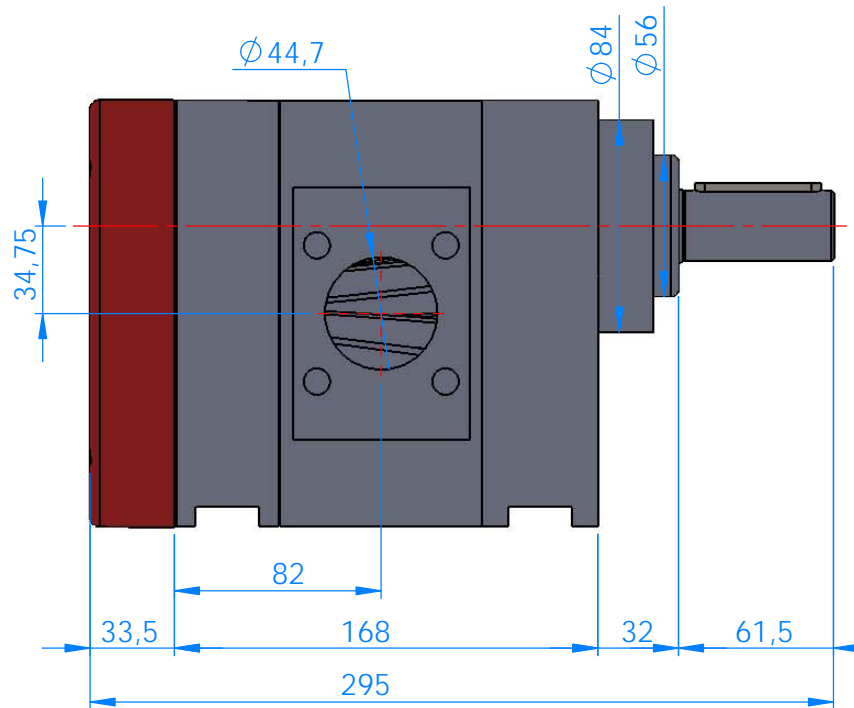

Chaveta DIN 6885/A 8X7X50
Goupille de sécurité DIN 6885/A 8X7X50
Cotter pin DIN 6885/A 8X7X50

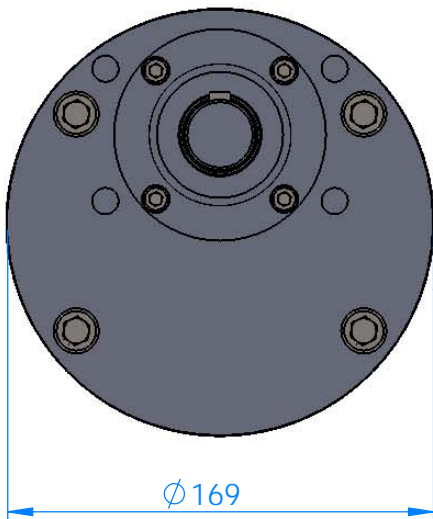