

PM130	
Caudal a 1500 R.P.M Débit à 1500 R.P.M Flow rate at 1500 R.P.M	130 l/min
Cilindrada Cylindrée Capacity	86.6 cc/v
R.P.M Max.	1500
Presión máxima Pression maxi Max.Presure	10 Bar
Temperatura máxima Température maximale Maximum temperature	120°C
Sentido de giro Sens de rotation Turning direction	Independiente Indépendant Independent

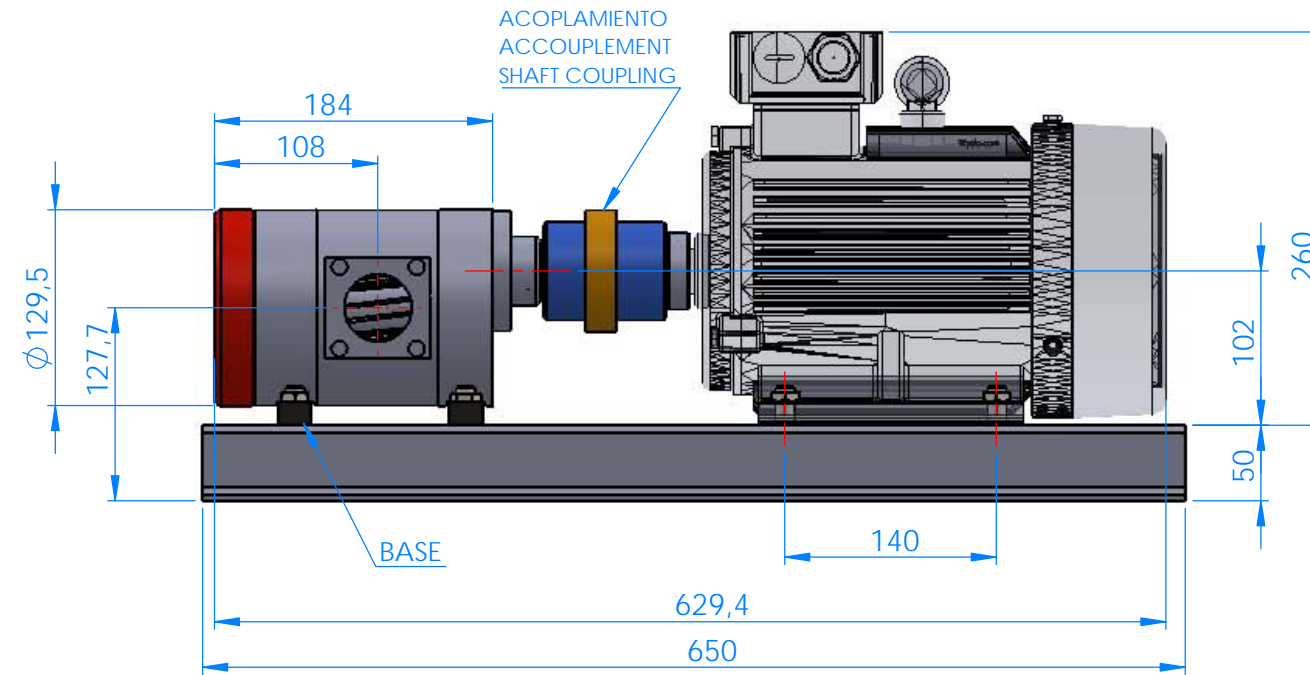

Motor B3	
Velocidad Vitesse Speed	1500 R.P.M
Potencia Puissance Power	3 C.V - 2.2 KW
Tensión Tension Tension	380-420V
Tipo Type Type	IEC 1A 100 L1-4

